

zenon
Gel Coat

Frame Korvit

PLATOS DE DUCHA
SHOWER TRAYS
RECEVEUR DE DOUCHE
PIATTI DOCCIA

zenon

PLATO DE DUCHA | SHOWER TRAYS | RECEVEUR DE DOUCHE | PIATTI DOCCIA | DUSCHWANNEN



FRAME
KORVIT

GEL COAT

SAGE

GEL COAT

INFORMACIÓN TÉCNICA

TECHNICAL INFORMATION | INFORMATION TECHNIQUE | INFORMAZIONE TECNICA | TECHNISCHE INFORMATION



i Series

Medidas disponibles

Available measures | Mesures disponibles | Misure disponibili | Verfügbare Grössen:

	B					
	100	120	140	160	180	
A	70	41	41	41	41	61
	80	41	41	41	41	61
						C

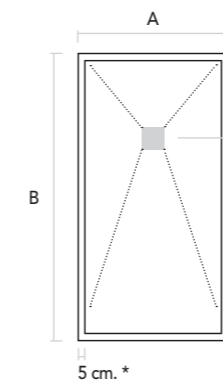

C Distancia centro desagüe
Center drain distance
Distance centre écoulement
Distanza centro scarico
Entfernung Abfluss-Mitte

* Borde - marco
Border - frame
Rebord - encadrement
Bordo - cornice
Rahmen - Rand

Medidas | Measures | Mesures
Misure | Grössen

Ancho: 5 cm. Alto: 0,9 cm.
Width High
Largeur Haute
Larghezza Alto
Breite Höhe



Rejilla inox estándar
Inox grid standard
Grille inox standard
Griglia inox standard
Abfluggitter Inox standard

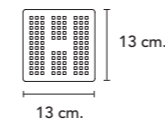

Válvula (estándar)
Standard valve
Bonde standard
Valvola standard
Ventil (standard)



Acabados
Finishing
Finition
Finitura
Ausführungen

KORVIT

Espesor
Thickness
Épaisseur
Spessore
Stärke

3,5 cm.

OPCIÓN | OPTION | OPTION | OPZIONE | OPTION

/ Colores estándar | Standard colours | Couleurs standard | Colori standard | Standardfarben



/ Rejilla inox color | Inox color grid | Grille couleur inox | Griglia inox a colore | Abfluggitter Inox Farbe

Toda la información / All the information / Toutes les informations / Tutte le informazioni / Gesamte Information pag. 44/47

OPCIONES PLATOS DUCHA

SHOWER TRAY OPTIONS | OPTION RECEVEURS DE DOUCHE | OPZIONE PIATTI DOCCIA | OPTIONEN DUSCHWANNEN

COLORES DISPONIBLES |

COLOURS AVAILABLE | COULEURS DISPONIBLES | COLORI DISPONIBILI | VERFÜGBARE FARBEN

ESTANDAR |

STANDARD | STANDARD | STANDARD | STANDARD

COBALT	 NEW	SAGE	 NEW	TERRACOTTA	 NEW
NATURAK		CREAM		MOKA	
NIEVE		NEW PEARL		PERLA	
CEMENTO		ANTRACITA		NEGRO	

Acabado | Finish | Finiton | Finitura | Ausführung SLATE · KORVIT · STONE

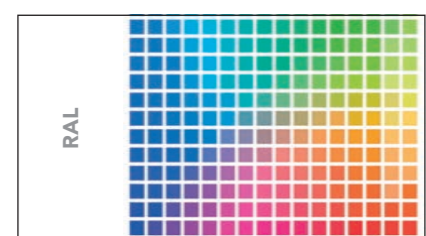

Disponibile también en todos los colores de la carta RAL |
Also available in all colors of RAL chart | Également disponible dans toutes les couleurs du nuancier RAL |
Disponibile anche in tutti i colori della carta RAL | Auch verfügbar in allen Farben aus der RAL karte

KIT DE REPARACIÓN

REPAIR KIT | KIT DE RÉPARATIONS | KIT DI RIPARAZIONE | REPARATIONSKIT

El trabajo de colocación de un nuevo baño puede ocasionar pequeños daños en los elementos con los que estamos trabajado, con frecuencia fruto de la rapidez de la instalación.

Zenon cuenta con un Mini Kit de reparación pensado especialmente en sus platos de ducha, que permite reparar rápida y fácilmente estos pequeños desperfectos ocasionados durante la instalación.

El kit consta de dos frascos, un rodillo de pintor para lacar, un recipiente y las instrucciones necesarias para realizar la reparación. También será necesaria una botella de alcohol, además de cinta de carrocer. Las instrucciones permitirán realizar la reparación de forma muy sencilla.

The installation work for a new bathroom can slightly damage the elements we are working with, often because of an installation that has been carried out too quickly.

Zenon has a repair Mini Kit specially designed for its shower trays, that allows the quick and easy repair of these small damages caused during installation.

The Repair kit consists of two bottles, a paint roller for lacquering, a container and the necessary instructions for carrying out the repair. We will also need a bottle of alcohol and masking tape. The instructions will allow us to carry out the repair quite easily.

Le travail d'installation d'une nouvelle salle de bains peut provoquer des dégâts sur les éléments sur lesquels on travail. Cela est très souvent dû à la rapidité de l'installation.

Zenon propose un Mini-Kit de réparation spécialement conçu pour ses receveurs de douche. Il permet de réparer rapidement et facilement ces petits dégâts qui apparaissent lors des travaux d'installation.

Le kit de réparations comprend deux flacons, un rouleau de peintre pour laquer, un récipient et les instructions nécessaires pour réaliser la réparation. Une bouteille d'alcool et un ruban de masquage seront également nécessaires. Les instructions permettent d'effectuer la réparation en toute simplicité.

Il lavoro di installazione di un nuovo bagno può provocare piccoli danni agli elementi con cui si sta lavorando, frequentemente a causa della velocità.

Zenon ha preparato un Mini Kit di riparazione ideato specialmente per i vostri piatti doccia, che consente di riparare rapidamente e facilmente le piccole imperfezioni arrecate durante l'installazione. Il kit di riparazione consta di due boccette, un rullo per pittura, un recipiente e le istruzioni necessarie per eseguire la riparazione. Sarà inoltre necessaria una bottiglia dell'alcool denaturato di carrozziere. Le istruzioni permetteranno di eseguire la riparazione in modo semplicissimo.

Beim Einbau eines neuen Badezimmers kann es zu kleineren Schäden an den Elementen kommen, mit denen wir arbeiten, was oft auf die Geschwindigkeit der Installation zurückzuführen ist.

Zenon bietet ein speziell für seine Duschwannen entwickeltes Reparaturset an, mit dem diese kleinen, beim Einbau entstandenen Schäden schnell und einfach behoben werden können. Das Set besteht aus zwei Flaschen, einem Farbroller, einem Behälter und der notwendigen Anleitung für die Reparatur. Sie benötigen außerdem eine Flasche Alkohol und Klebeband. Mit Hilfe der Anleitung ist die Reparatur sehr einfach durchzuführen.

Mini Kit de pintura

Mini paint Kit | Mini-Kit de peinture | Mini Kit di pittura | Mini-Bemalungsset



Kit de reparación

Repair kit | Kit de réparations | Kit di riparazione | Reparationskit



ADHESIVO

ADHESIVE | ADHÉSIF | ADESIVO | KLEBSTOFF

Adhesivo y sellador multiuso monocomponente

Multi-purpose one-component adhesive and sealer
Adhésif et scellant multi-usages mono-composant
Adesivo e sigillante multiuso monocomponente
Einkomponentiger Mehrzweckklebstoff und Dichtstoff

MAPEI



OPCIONES PLATOS DUCHA

SHOWER TRAY OPTIONS | OPTION RECEVEURS DE DOUCHE | OPZIONE PIATTI
DOCCIA | OPTIONEN DUSCHWANNEN

VÁLVULA

VALVE | BONDE | VALVOLA | VENTIL

DOMO HORIZONTAL 35 l./min. Caudal | Flow | Flux | Flusso | Durchfluss

Medidas | Measurements | Dimensions | Misure | Größen:

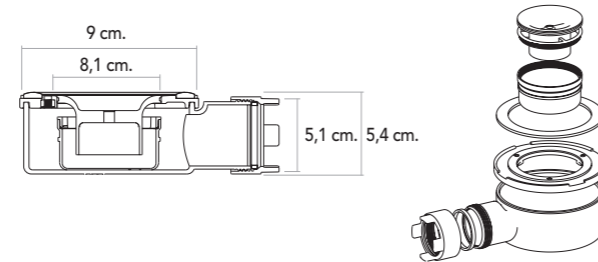
Para platos | For trays | Pour receveurs | Per piatti | Für Duschwannen
SMART / FRAME / EVOLUTION / ANGULAR / MAUI / BALI / CAPRI**DOMO VERTICAL** 35 l./min. Caudal | Flow | Flux | Flusso | Durchfluss

Medidas | Measurements | Dimensions | Misure | Größen:

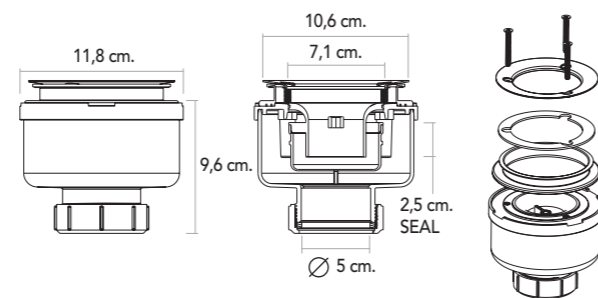
Para platos | For trays | Pour receveurs | Per piatti | Für Duschwannen
SMART / FRAME / EVOLUTION / ANGULAR / MAUI / BALI / CAPRI**IGLU** 27 l./min. Caudal | Flow | Flux | Flusso | Durchfluss

Medidas | Measurements | Dimensions | Misure | Größen:

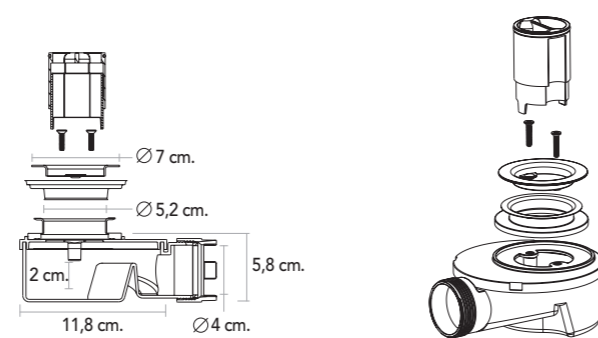
Para platos | For trays | Pour receveurs | Per piatti | Für Duschwannen
NASSAU / FIJI**BLOCK** 60 l./min. Caudal | Flow | Flux | Flusso | Durchfluss

Medidas | Measurements | Dimensions | Misure | Größen:

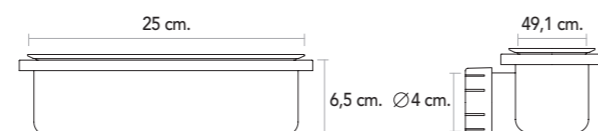
Para platos | For trays | Pour receveurs | Per piatti
SIDE / WEST

ADAPTABLE AL ESPACIO

ADAPTABLE TO THE SPACE | ADAPTABLE À L'ESPACE
ADATTABILE ALLO SPAZIO | RAUMANPASSUNGSFÄHIG

Corte a medida del plato de ducha.

Custom cut on the shower tray.

Coupe personnalisée dans le receveur de douche.

Taglio personalizzato del piatto doccia.

Duschwannen- Schnitt nach Massangabe.

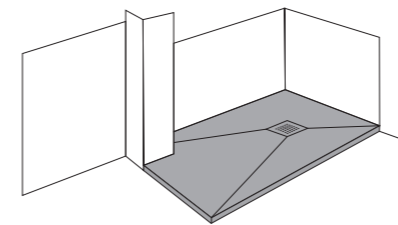

ZONA DE SECADO

DRYING AREA | ZONE DE SÉCHAGE |

AREA DI ASCIUGATURA | TROCKNUNGSBEREICH

Pieza plana anexa al plato de ducha.

Flat piece attached to the shower tray.

Pièce plate annexée au receveur de douche.

Pezzo piano attaccato al piatto doccia.

An der Duschwanne angesetztes Flachstück.

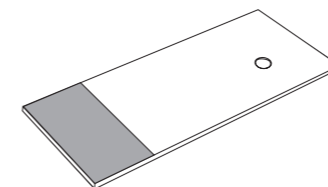

REJILLA

GRID | GRILLE | GRIGLIA | ABFLUSSGITTER

Rejilla personalizable en inox y en nuestros COLORES ESTÁNDAR.

Customisable stainless steel grids in our STANTARD COLOURS.

Grille acier inoxydable personnalisables dans nos COULEURS STANTARD.

Griglia personalizzabili in acciaio inox nei nostri COLORI STANTARD.

Personalisierter Abflaugitter in Inox und in unseren STANDARD FARBEN.

